

# Smart Library 26

## Inventory

00 Presentation & Drafting  
01 Reference & Annotation  
02 Landscaping  
03 Structure  
04 Enclosure  
05 Interior  
06 Finishes  
07 Mechanical  
08 Hydraulic  
09 Electrical  
M Master  
AS Australian Standards

Folder 01

Folder 02

Folder 03

Library Part Name

2D Plan Preview

3D Axonometry

00 Presentation

Parasol

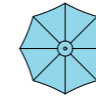

00 Presentation

People

Smart People



00 Presentation

People

Smart People



00 Presentation

People

Smart People



Folder 01

Folder 02

Folder 03

Library Part Name

2D Plan Preview

3D Axonometry

00 Presentation

People

New

Child 01



00 Presentation

People

New

Couple 01

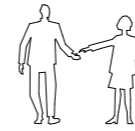

00 Presentation

People

New

Man 01



00 Presentation

People

New

Man 01 Woman 01



Folder 01

Folder 02

Folder 03

Library Part Name

2D Plan Preview

3D Axonometry

00 Presentation

People

New

Man 02



00 Presentation

People

New

Man 03



00 Presentation

People

New

Man 04



00 Presentation

People

New

Man 05



Folder 01

Folder 02

Folder 03

Library Part Name

2D Plan Preview

3D Axonometry

00 Presentation

People

New

Man 06



00 Presentation

People

New

Man 07



00 Presentation

People

New

Man 08



00 Presentation

People

New

Man 09



Folder 01

Folder 02

Folder 03

Library Part Name

2D Plan Preview

3D Axonometry

00 Presentation

People

New

Woman 01



00 Presentation

People

New

Woman 02



00 Presentation

People

New

Woman 03



00 Presentation

People

New

Woman 04



Folder 01

Folder 02

Folder 03

Library Part Name

2D Plan Preview

3D Axonometry

00 Presentation

People

New

Woman 05



00 Presentation

Vehicles

Carpark Arrow - 90  
Degrees



00 Presentation

Vehicles

Carpark Arrow - Straight



00 Presentation

Vehicles

Carpark Arrow - Straight  
and 90 Degrees



Folder 01

Folder 02

Folder 03

Library Part Name

2D Plan Preview

3D Axonometry

00 Presentation

Vehicles

Carpark Arrow - T

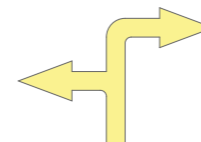



01 Reference and Annotation

Accessible Symbol



01 Reference and Annotation

MultiStory Polyline



01 Reference and Annotation

Smart Document Transmittal

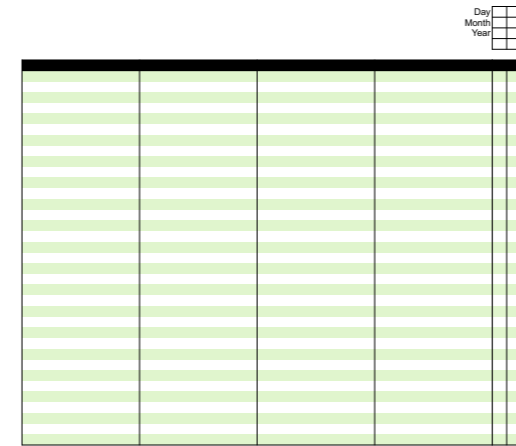

01 Reference and Annotation

Smart Template Info

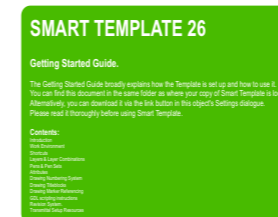

01 Reference and Annotation

Smart WWW links

**SELECT THIS OBJECT  
OPEN THE SETTINGS DIALOGUE  
GO TO [ MAC I N T E R A C T ] TAB  
CLICK RELEVANT LINK**

01 Reference and Annotation

Annotaion Detail

Align Symbol



01 Reference and Annotation

Annotation Detail

Break Line

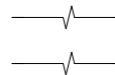

01 Reference and Annotation

Annotation Detail

Break Line

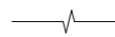

Folder 01

Folder 02

Folder 03

Library Part Name

2D Plan Preview

3D Axonometry

01 Reference and Annotation

Annotation Detail

Smart Advanced Dimension Marker

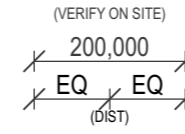

01 Reference and Annotation

Annotation Detail

Smart EQ Dimension Marker

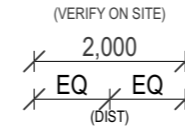

01 Reference and Annotation

Annotation Detail

Smart EQ Dimension Marker

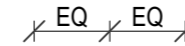

01 Reference and Annotation

Annotation Detail

Smart EQ Dimension Marker

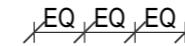



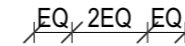

01 Reference and Annotation

Annotation Detail

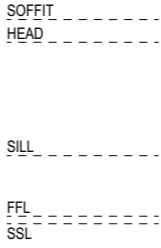
Smart EQ Dimension Marker



Folder 01	Folder 02	Folder 03	Library Part Name	2D Plan Preview	3D Axonometry
01 Reference and Annotation	Annotation Detail		Smart Level Marker		
01 Reference and Annotation	Annotation Finishes		Smart Setout Marker		
01 Reference and Annotation	Annotation Finishes		Smart Setout Marker		
01 Reference and Annotation	Annotation Finishes		Smart Setout Marker		
01 Reference and Annotation	Annotation Labels		RCP Dimension Label 18		

Folder 01

Folder 02

Folder 03

Library Part Name

2D Plan Preview

3D Axonometry

01 Reference and Annotation

Annotation Labels

Smart Custom Label

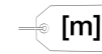

01 Reference and Annotation

Annotation Labels

Smart Mechanical Vent Label



01 Reference and Annotation

Annotation Labels

Smart Universal Label

ID:	S1
A:	9.73 m <sup>2</sup>
V:	1.95 m <sup>3</sup>
Fire Rating	90/90/90

01 Reference and Annotation

Annotation Labels

Smart Wall Label Parallel

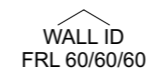

01 Reference and Annotation

Annotation Labels

Smart Wall Label Perpendicular



Folder 01

Folder 02

Folder 03

Library Part Name

2D Plan Preview

3D Axonometry

01 Reference and Annotation

Annotation Labels

Wall Level Marker

WALL HEIGHT+3.000 mm

01 Reference and Annotation

Annotation Site Analysis

Bus Icon



01 Reference and Annotation

Annotation Site Analysis

Cross Ventilation Icon



01 Reference and Annotation

Annotation Site Analysis

Half Sun Icon



01 Reference and Annotation

Annotation Site Analysis

Smart Views from the Sun

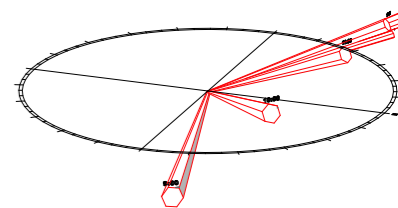
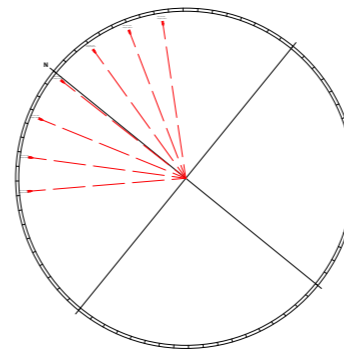

01 Reference and Annotation

Annotation Site Analysis

Solar Diagram

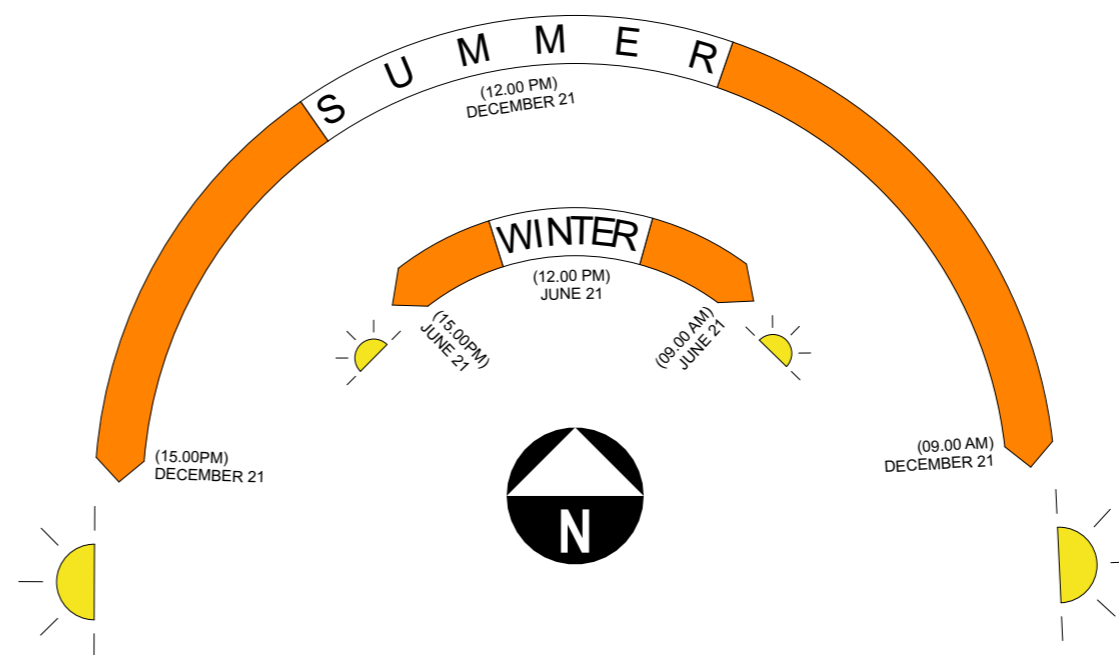

01 Reference and Annotation

Annotation Site Analysis

Stamp with Tick or Cross



01 Reference and Annotation

Annotation Site Analysis

Stamp with Tick or Cross



01 Reference and Annotation

Annotation Site Analysis

Sun Icon

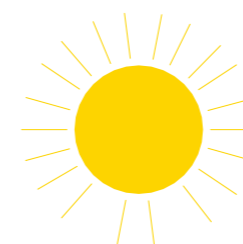

Folder 01

Folder 02

Folder 03

Library Part Name

2D Plan Preview

3D Axonometry

01 Reference and Annotation

Annotation Site Analysis

Wind Diagram

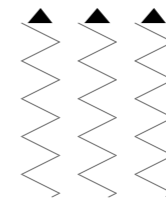

Moderate North Winds

01 Reference and Annotation

Annotation Site Analysis

Arrow with Text



01 Reference and Annotation

Annotation Structure

Break Line Round



01 Reference and Annotation

Annotation Structure

Hob



01 Reference and Annotation

Annotation Structure

Hob to Edge





Folder 01

Folder 02

Folder 03

Library Part Name

2D Plan Preview

3D Axonometry

01 Reference and Annotation

Annotation Structure

RiserCross



01 Reference and Annotation

Annotation Structure

RiserCross



01 Reference and Annotation

Annotation Structure

Setdown - Double



01 Reference and Annotation

Annotation Structure

Setdown - Single



01 Reference and Annotation

Annotations Structure

Smart 3DRiser

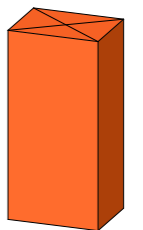
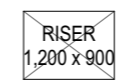

Folder 01

Folder 02

Folder 03

Library Part Name

2D Plan Preview

3D Axonometry

01 Reference and Annotation

Cloud Revision

Cloud - Rect b



01 Reference and Annotation

Cloud Revision

Cloud Revision Rectangular

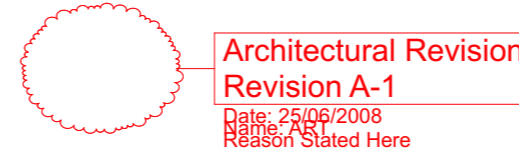

01 Reference and Annotation

Cloud Revision

Cloud Revision Rectangular



01 Reference and Annotation

Cloud Revision

Cloud-Rect-OD



01 Reference and Annotation

Cloud Revision

Cloud-Round-OD

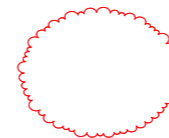

Folder 01

Folder 02

Folder 03

Library Part Name

2D Plan Preview

3D Axonometry

01 Reference and Annotation

Reference Drawing Markers

Basic Story Marker

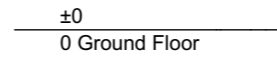

01 Reference and Annotation

Reference Drawing Markers

Slab Level Marker

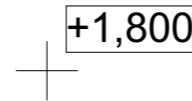

01 Reference and Annotation

Reference Drawing Markers

Smart Detail Marker

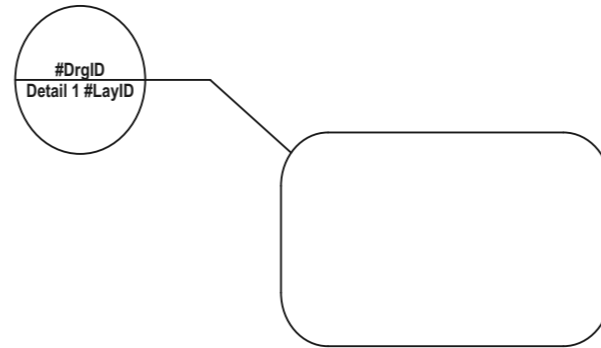

01 Reference and Annotation

Reference Drawing Markers

Smart Dimension Reference Marker

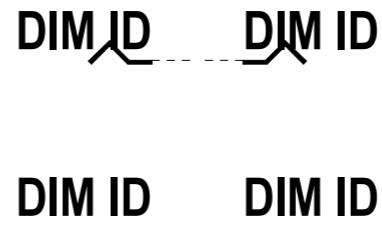

01 Reference and Annotation

Reference Drawing Markers

Smart Section-Elevation Marker



01 Reference and Annotation

Reference Drawing Markers

Smart Worksheet Marker

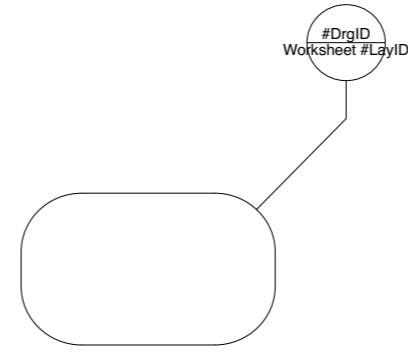

01 Reference and Annotation

Reference Drawing Markers

Storey Level Marker



01 Reference and Annotation

Reference Drawing Markers

Storey Level Marker Independent



01 Reference and Annotation

Reference Drawing Markers

mACT Story Marker

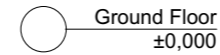

01 Reference and Annotation

Titleblock

Design Practitioner Title Block

Regulated Design Record				
Project Address: Project Street Address Suburb State Postcode Country				
Project Title: Smart Template 25				
Consent No:		Body Corp Reg No:		
Drawing Title: #Layout Name		Drawing No: #LayID		
Rev	Date dd.mm.yy	Description	DP Full Name	Reg No

**SMART**

Folder 01

Folder 02

Folder 03

Library Part Name

2D Plan Preview

3D Axonometry

01 Reference and Annotation

Titleblock

Smart Disclaimer

These record drawings have been prepared based on information provided by others. INSERTCOMPANYNAMEHERE has not verified the accuracy and/or completeness of this information and shall not be responsible for any errors or omissions which may be incorporated into the drawings as a result.

01 Reference and Annotation

Titleblock

Smart Layout Name and Revision

Ground Level

01 Reference and Annotation

Titleblock

Smart North Point



01 Reference and Annotation

Titleblock

Smart North Point



01 Reference and Annotation

Titleblock

Smart Sheet Number and Revision

A-SK-001-001

Folder 01

Folder 02

Folder 03

Library Part Name

2D Plan Preview

3D Axonometry

02 Site and Landscape Planting

Pot Plant

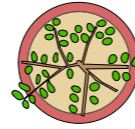

02 Site and Landscape Planting

Pot Plants

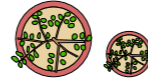

02 Site and Landscape Planting

Shrub 01



02 Site and Landscape Planting

Shrub 01



02 Site and Landscape Planting

Smart Tree



Folder 01

Folder 02

Folder 03

Library Part Name

2D Plan Preview

3D Axonometry

02 Site and Landscape Planting

Smart Tree



02 Site and Landscape Planting

Smart Tree

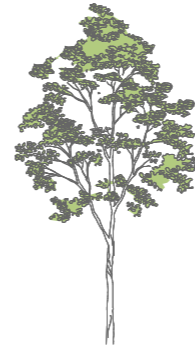

02 Site and Landscape Planting

Tree 2D

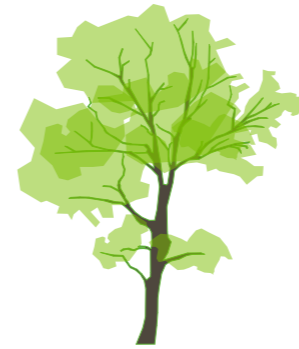

02 Site and Landscape Planting

Tree\_01

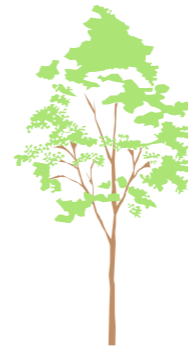

02 Site and Landscape Planting

Tree\_02

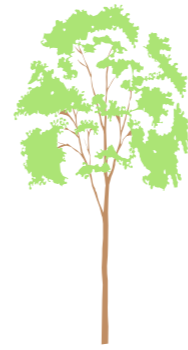

Folder 01

Folder 02

Folder 03

Library Part Name

2D Plan Preview

3D Axonometry

02 Site and Landscape Planting

Tree\_03



02 Site and Landscape Planting

Tree\_04

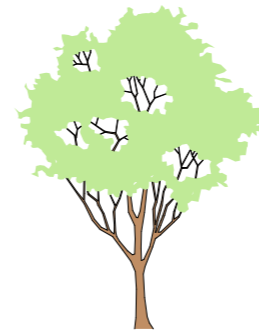

02 Site and Landscape Planting

hello

Bamboo





Folder 01

Folder 02

Folder 03

Library Part Name

2D Plan Preview

3D Axonometry

03 Structure

Masonry Unit Modules



Folder 01

Folder 02

Folder 03

Library Part Name

2D Plan Preview

3D Axonometry

Folder 01

Folder 02

Folder 03

Library Part Name

2D Plan Preview

3D Axonometry

N

05 Interior

Equipment

Cooktop\_2Burner



05 Interior

Equipment

Cooktop\_4Burner



05 Interior

Equipment

Cooktop\_4Burner 02

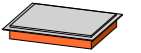

05 Interior

Equipment

Fridge



05 Interior

Equipment

Garbage Bin



Folder 01

Folder 02

Folder 03

Library Part Name

2D Plan Preview

3D Axonometry

N

05 Interior

Equipment

Garbage Bin 1100

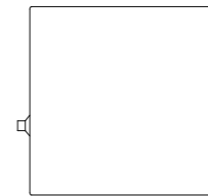

05 Interior

Equipment

Garbage Compactor

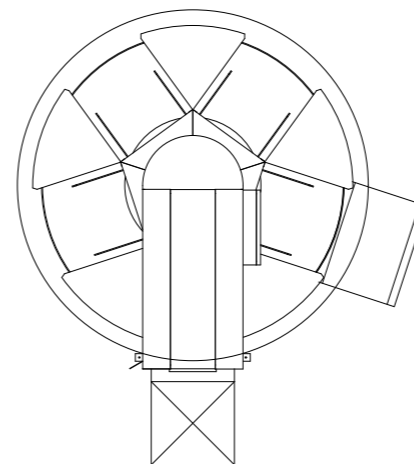

05 Interior

Equipment

Garbage Shute

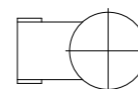

05 Interior

Equipment

Lamp 01



Folder 01

Folder 02

Folder 03

Library Part Name

2D Plan Preview

3D Axonometry

N

05 Interior

Equipment

TV\_01

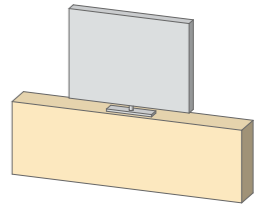

05 Interior

Equipment

TV\_02

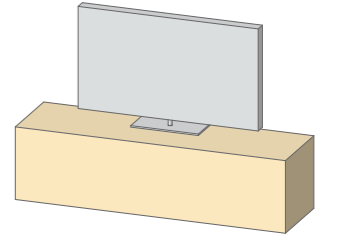
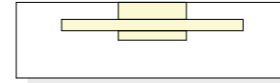

05 Interior

Equipment

TV\_03

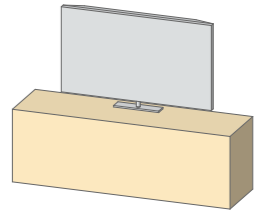
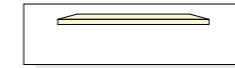

05 Interior

Equipment

Washing Machine

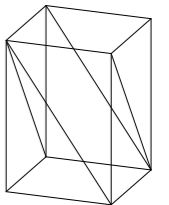

05 Interior

Furniture Fixed

Rail



Folder 01

Folder 02

Folder 03

Library Part Name

2D Plan Preview

3D Axonometry

N

05 Interior

Furniture Fixed

Shelve



05 Interior

Furniture Fixed

Towel\_Rail

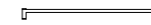

05 Interior

Furniture Fixed

Towel\_Rail\_600



05 Interior

Furniture Fixed

Towel\_Rail\_630



05 Interior

Furniture Fixed

WC Roll Holder



Folder 01

Folder 02

Folder 03

Library Part Name

2D Plan Preview

3D Axonometry

N

05 Interior

Furniture  
Loose

Bed\_Double

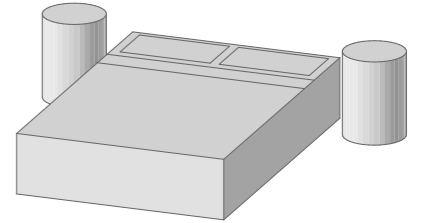
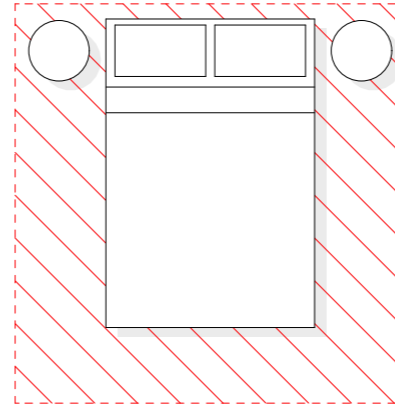

05 Interior

Furniture  
Loose

Bed\_Queen

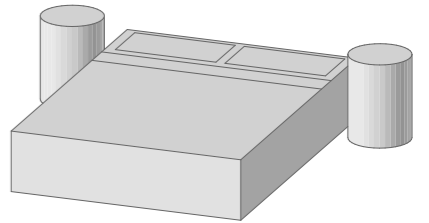
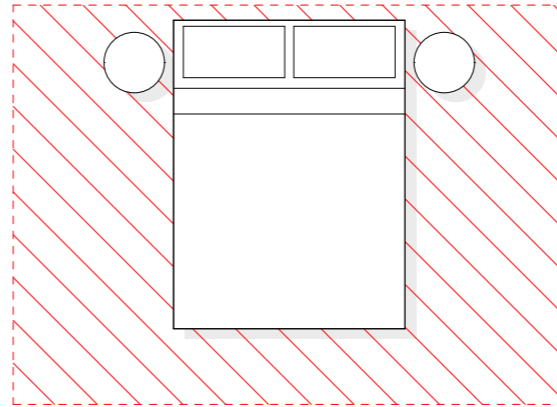

05 Interior

Furniture  
Loose

Coffee Table 01

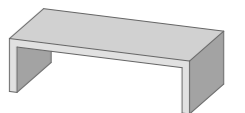

05 Interior

Furniture  
Loose

Coffee Table 02

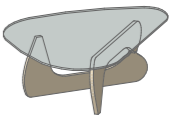
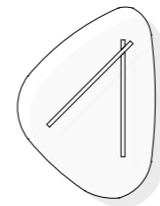

05 Interior

Furniture  
Loose

Coffee Table 03

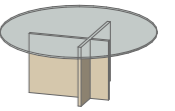
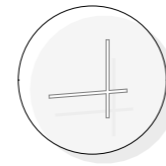

05 Interior

Furniture  
Loose

Dining Table\_Rectangular

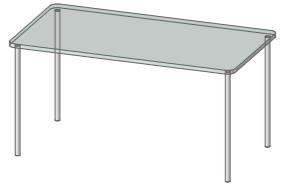

05 Interior

Furniture  
Loose

Dining Table\_Round

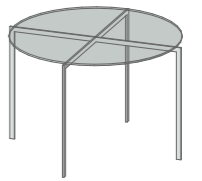
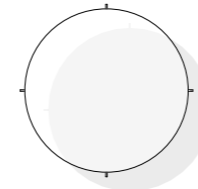

05 Interior

Furniture  
Loose

Dining\_4 Seat\_Round

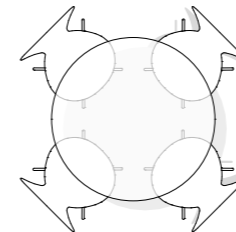

05 Interior

Furniture  
Loose

Dining\_4 Seat\_Straight

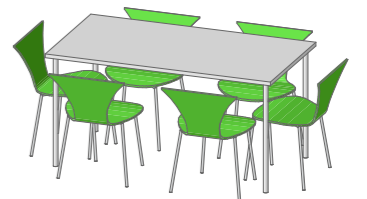
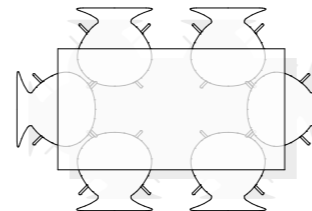



05 Interior

Furniture  
Loose

Dining\_6 Seat\_Straight

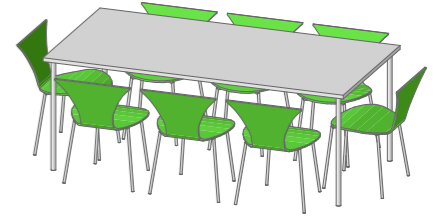
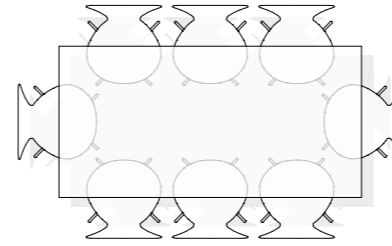

05 Interior

Furniture  
Loose

Dining\_Rectangular

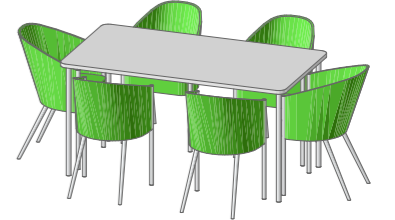
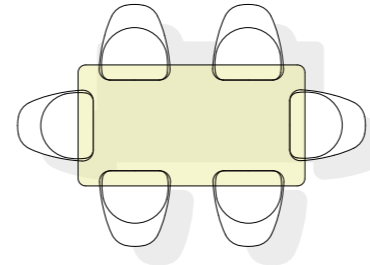

05 Interior

Furniture  
Loose

Dining\_Round

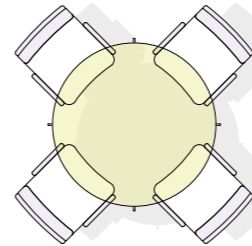

05 Interior

Furniture  
Loose

Living\_02 Layout

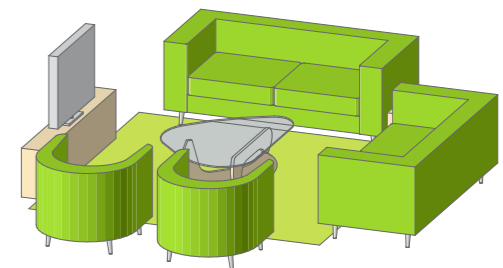
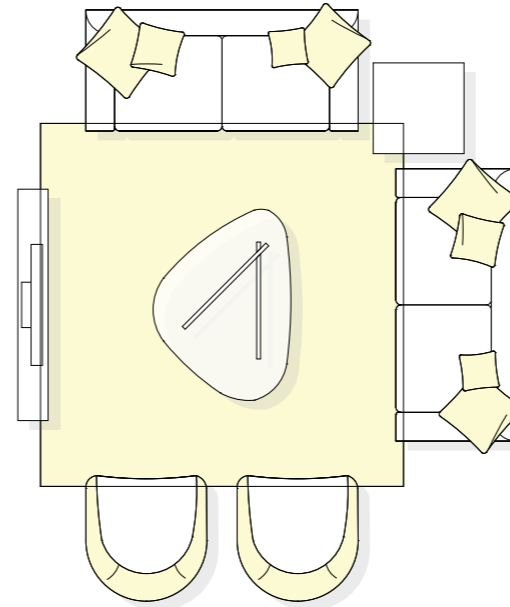

Folder 01

Folder 02

Folder 03

Library Part Name

2D Plan Preview

3D Axonometry

N

05 Interior

Furniture  
Loose

Living Layout

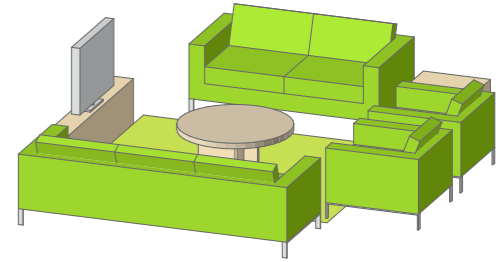
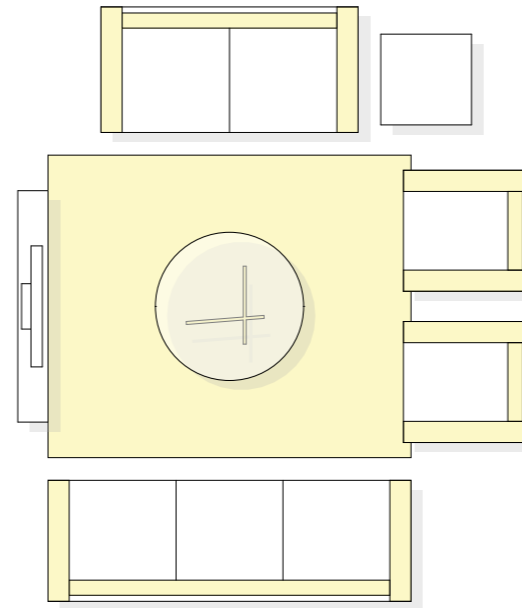

05 Interior

Furniture  
Loose

Robe

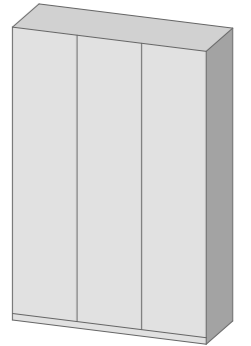

05 Interior

Furniture  
Loose

Seat



05 Interior

Furniture  
Loose

Seat 02

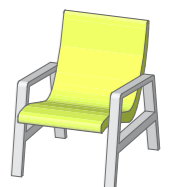

Folder 01

Folder 02

Folder 03

Library Part Name

2D Plan Preview

3D Axonometry

N

05 Interior

Furniture  
Loose

Seat 03



05 Interior

Furniture  
Loose

Seat 04



05 Interior

Furniture  
Loose

Seat 05



05 Interior

Furniture  
Loose

Seat 06

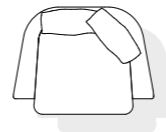

05 Interior

Furniture  
Loose

Seat 07

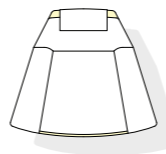

Folder 01

Folder 02

Folder 03

Library Part Name

2D Plan Preview

3D Axonometry

N

05 Interior

Furniture  
Loose

Seat 08

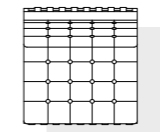

05 Interior

Furniture  
Loose

Seat 09

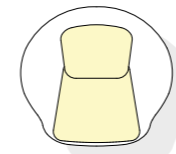

05 Interior

Furniture  
Loose

Seat 10

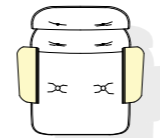

05 Interior

Furniture  
Loose

Seat 11



05 Interior

Furniture  
Loose

Seat\_Profile



05 Interior

Furniture  
Loose

Smart\_Bed\_Maker

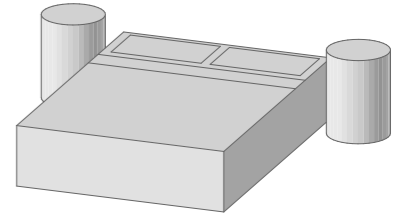
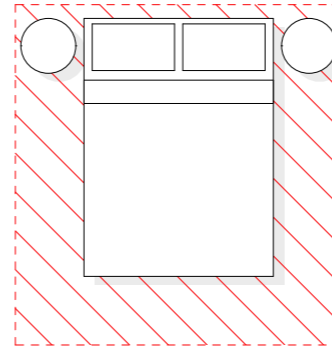

05 Interior

Furniture  
Loose

Smart\_Bed\_Maker

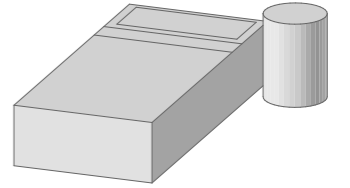
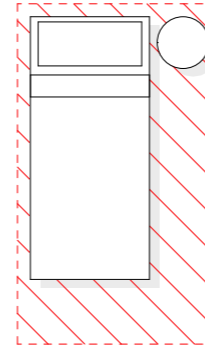

05 Interior

Furniture  
Loose

Sofa - Double

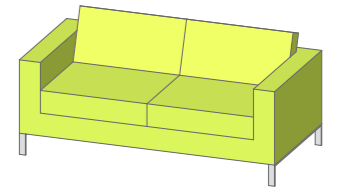
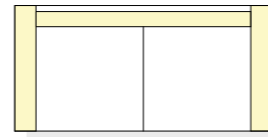

05 Interior

Furniture  
Loose

Sofa - Single

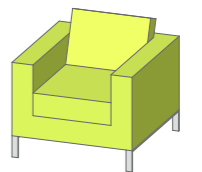
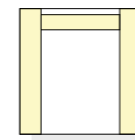

05 Interior

Furniture  
Loose

Sofa - Triple

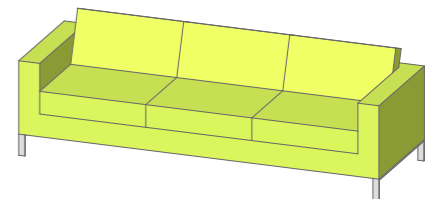
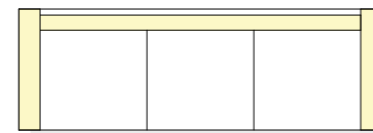

05 Interior

Furniture  
Loose

Sofa 02 - Double

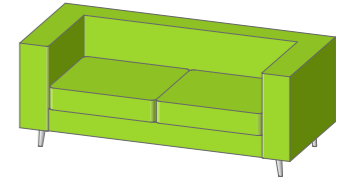
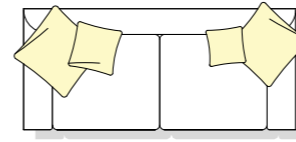

05 Interior

Furniture  
Loose

Sofa 02 - Single

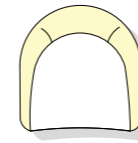

05 Interior

Furniture  
Loose

Sofa 02 - Triple

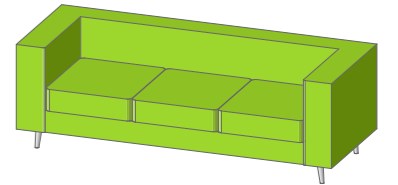
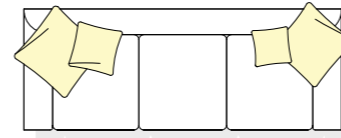

05 Interior

Furniture  
Loose

Study Layout 01

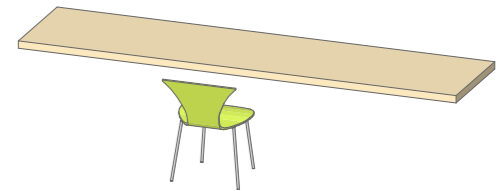
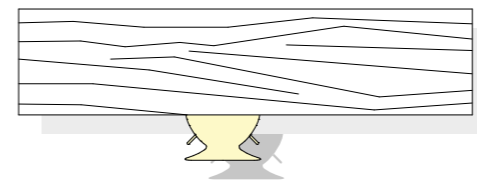



05 Interior





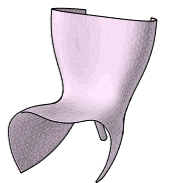

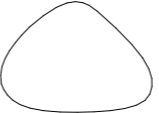
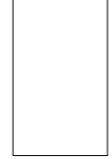
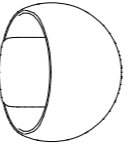
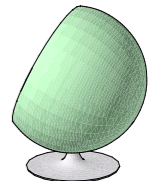

Furniture  
Loose

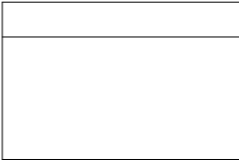
High Poly  
Furniture

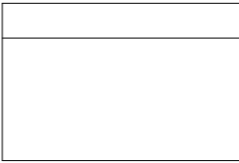
Cappellini Felt Chair

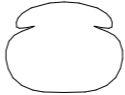

Folder 01	Folder 02	Folder 03	Library Part Name	2D Plan Preview	3D Axonometry
05 Interior	Furniture Loose	High Poly Furniture	Chair 1		
05 Interior	Furniture Loose	High Poly Furniture	Coffee Table 1		
05 Interior	Furniture Loose	High Poly Furniture	Coffee Table 2		
05 Interior	Furniture Loose	High Poly Furniture	Eero Aarnio Ball Chair		
05 Interior	Furniture Loose	High Poly Furniture	Minotti Hamilton Sofa 1		

Folder 01	Folder 02	Folder 03	Library Part Name	2D Plan Preview	3D Axonometry
05 Interior	Furniture Loose	High Poly Furniture	Minotti Hamilton Sofa 2		
05 Interior	Furniture Loose	High Poly Furniture	Minotti Hamilton Sofa 3		
05 Interior	Furniture Loose	High Poly Furniture	Stool 1		
05 Interior	Furniture Loose	High Poly Furniture	Swan Chair		



Folder 01

Folder 02

Folder 03

Library Part Name

2D Plan Preview

3D Axonometry

Folder 01

Folder 02

Folder 03

Library Part Name

2D Plan Preview

3D Axonometry

07 Mechanical

Condenser Unit

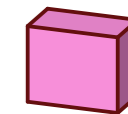
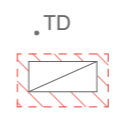

07 Mechanical

Lift 01

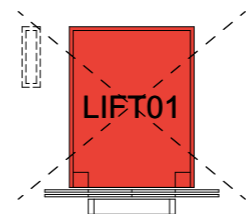

07 Mechanical

Lift 01

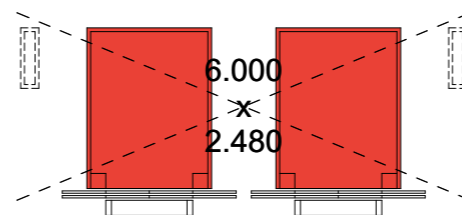

Folder 01

Folder 02

Folder 03

Library Part Name

2D Plan Preview

3D Axonometry

08 Hydraulic

Fire

Fire Hose



08 Hydraulic

Fire

Fire Hose 02



08 Hydraulic

Fire

Fire Hose Reel

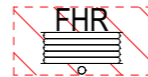

08 Hydraulic

Fixtures

Basin 01



08 Hydraulic

Fixtures

Basin 02\_Double

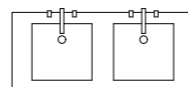

Folder 01

Folder 02

Folder 03

Library Part Name

2D Plan Preview

3D Axonometry

08 Hydraulic

Fixtures

Basin 03



08 Hydraulic

Fixtures

Basin 04



08 Hydraulic

Fixtures

Basin 04



08 Hydraulic

Fixtures

Basin 04



08 Hydraulic

Fixtures

Basin\_Caroma\_Cube



Folder 01

Folder 02

Folder 03

Library Part Name

2D Plan Preview

3D Axonometry

08 Hydraulic

Fixtures

Bath\_01

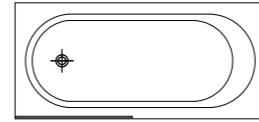

08 Hydraulic

Fixtures

Bath\_02

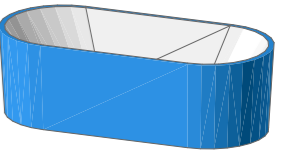
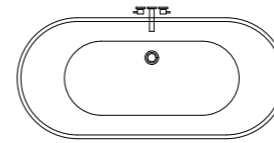

08 Hydraulic

Fixtures

Bath\_02

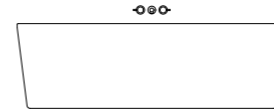

08 Hydraulic

Fixtures

Bath\_02

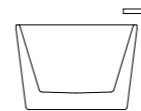

08 Hydraulic

Fixtures

Bath\_03

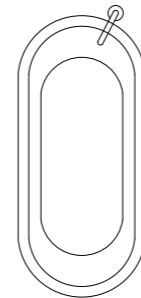

Folder 01

Folder 02

Folder 03

Library Part Name

2D Plan Preview

3D Axonometry

08 Hydraulic

Fixtures

Bidet Floor



08 Hydraulic

Fixtures

Bidet Wall Hung



08 Hydraulic

Fixtures

Connection Point



08 Hydraulic

Fixtures

Floor Drain



08 Hydraulic

Fixtures

Floor Drain - Smart Tile



Folder 01

Folder 02

Folder 03

Library Part Name

2D Plan Preview

3D Axonometry

08 Hydraulic

Fixtures

Kitchen Sink



08 Hydraulic

Fixtures

Kitchen Sink - Double

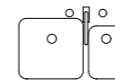

08 Hydraulic

Fixtures

Kitchen Sink - Double 02

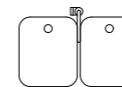

08 Hydraulic

Fixtures

Kitchen Sink - Double 03

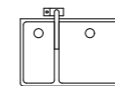

08 Hydraulic

Fixtures

Kitchen Sink - Double 04

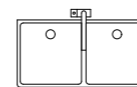

Folder 01

Folder 02

Folder 03

Library Part Name

2D Plan Preview

3D Axonometry

08 Hydraulic

Fixtures

Laundry T01

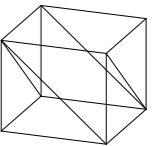
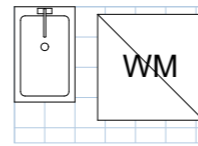

08 Hydraulic

Fixtures

Shower

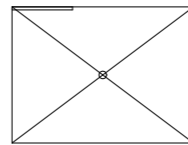

08 Hydraulic

Fixtures

Shower Head 01



08 Hydraulic

Fixtures

Shower Head 01



08 Hydraulic

Fixtures

Shower Head 01





Folder 01

Folder 02

Folder 03

Library Part Name

2D Plan Preview

3D Axonometry

08 Hydraulic

Fixtures

Sink for Cleaner



08 Hydraulic

Fixtures

Smart Basin

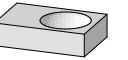
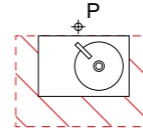

08 Hydraulic

Fixtures

Smart Basin

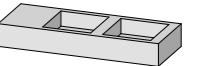
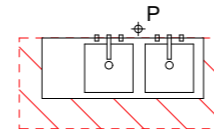

08 Hydraulic

Fixtures

Smart Bath

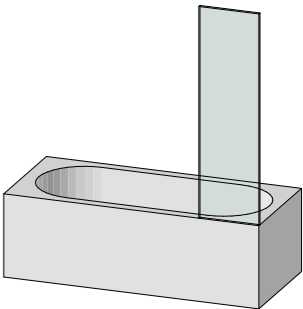
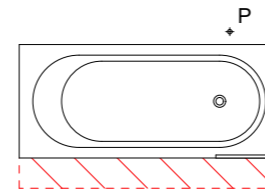

08 Hydraulic

Fixtures

Smart Bath

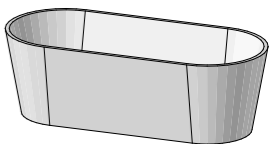
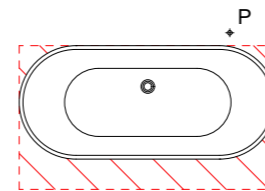

Folder 01

Folder 02

Folder 03

Library Part Name

2D Plan Preview

3D Axonometry

08 Hydraulic

Fixtures

Smart Shower

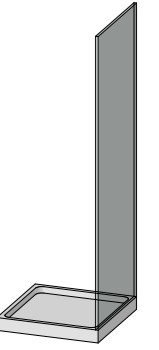
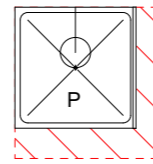

08 Hydraulic

Fixtures

Smart Shower

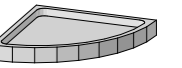
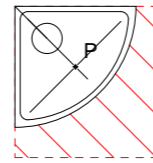

08 Hydraulic

Fixtures

Smart Shower

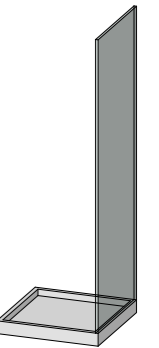
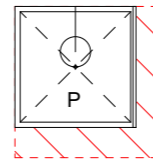

08 Hydraulic

Fixtures

Smart Toilet

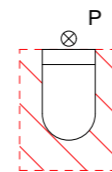

08 Hydraulic

Fixtures

Smart Toilet

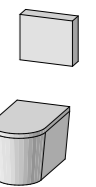
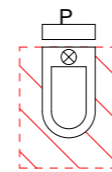

Folder 01

Folder 02

Folder 03

Library Part Name

2D Plan Preview

3D Axonometry

08 Hydraulic

Fixtures

Toilet\_01



08 Hydraulic

Fixtures

Toilet\_02

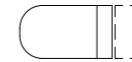

08 Hydraulic

Fixtures

Tub 01

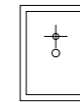

08 Hydraulic

Fixtures

Tub 02

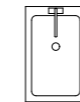

08 Hydraulic

Fixtures

WC Floor Standing



Folder 01

Folder 02

Folder 03

Library Part Name

2D Plan Preview

3D Axonometry

08 Hydraulic

Fixtures

WC Wall Hung 1



08 Hydraulic

Fixtures

WC Wall Hung 2



08 Hydraulic

Fixtures

mACT Floor Waste  
Symbol



08 Hydraulic

Fixtures

mACT Floor Waste  
Symbol



Folder 01

Folder 02

Folder 03

Library Part Name

2D Plan Preview

3D Axonometry

09 Electrical

Communication - Data



09 Electrical

Communication - Data  
Floor



09 Electrical

Communication -  
Emergency Speaker



09 Electrical

Communication -  
Evacuation System



09 Electrical

Communication - Smoke  
Alarm



Folder 01

Folder 02

Folder 03

Library Part Name

2D Plan Preview

3D Axonometry

09 Electrical

Communication - Speaker



09 Electrical

Communication -  
Telephone



09 Electrical

Communication -  
Telephone Floor



09 Electrical

Communication -  
Television



09 Electrical

Communication -  
Television Floor



Folder 01

Folder 02

Folder 03

Library Part Name

2D Plan Preview

3D Axonometry

09 Electrical

Distribution - Distribution and Switch Board



09 Electrical

Distribution - Main Switch Board



09 Electrical

Distribution - Meter Panel



09 Electrical

Distribution - NBN



09 Electrical

Electrical Control



Folder 01

Folder 02

Folder 03

Library Part Name

2D Plan Preview

3D Axonometry

09 Electrical

Electrical Control

↳<sup>2</sup>

09 Electrical

Electrical Control

↳<sup>3</sup>

09 Electrical

Electrical Control

↳<sup>1D</sup>

09 Electrical

Electrical Control

↳<sup>2D</sup>

09 Electrical

Electrical Control

Ⓢ



Folder 01

Folder 02

Folder 03

Library Part Name

2D Plan Preview

3D Axonometry

09 Electrical

Electrical Control



09 Electrical

Electrical Outlet



09 Electrical

Electrical Outlet



09 Electrical

Electrical Outlet



09 Electrical

Electrical Outlet



Folder 01

Folder 02

Folder 03

Library Part Name

2D Plan Preview

3D Axonometry

09 Electrical

Electrical Outlet



09 Electrical

Electrical Outlet



09 Electrical

Electrical Outlet



09 Electrical

Electrical Outlet



09 Electrical

Electrical Outlet



Folder 01

Folder 02

Folder 03

Library Part Name

2D Plan Preview

3D Axonometry

09 Electrical

Fire - Fire Indicator Panel

FIP

09 Electrical

Fire - MIMIC Panel

MIMIC

09 Electrical

Fire - Smoke Detector



09 Electrical

Fire - Sprinkler



09 Electrical

Fire - Sprinkler Wall



Folder 01

Folder 02

Folder 03

Library Part Name

2D Plan Preview

3D Axonometry

09 Electrical

Fire - Thermal Detector



09 Electrical

Fire - Wall Wetting  
Drencher



09 Electrical

Fire - Warden Intercom  
Point



09 Electrical

GPO - Double



09 Electrical

GPO - Double Floor



Folder 01

Folder 02

Folder 03

Library Part Name

2D Plan Preview

3D Axonometry

09 Electrical

GPO - Isolation Switch



09 Electrical

GPO - Single



09 Electrical

GPO - Single Floor



09 Electrical

Lights - Bollard



09 Electrical

Lights - Directional



Folder 01

Folder 02

Folder 03

Library Part Name

2D Plan Preview

3D Axonometry

09 Electrical

Lights - Directional Wall

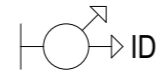

09 Electrical

Lights - Downlight



09 Electrical

Lights - Downlight Wall



09 Electrical

Lights - Emergency Light



09 Electrical

Lights - Exit Light



Folder 01

Folder 02

Folder 03

Library Part Name

2D Plan Preview

3D Axonometry

09 Electrical

Lights - Exit Light Wall



09 Electrical

Lights - Fan with Light



09 Electrical

Lights - Fluorescent



09 Electrical

Lights - Motion Sensor



09 Electrical

Lights - Pendant



Folder 01

Folder 02

Folder 03

Library Part Name

2D Plan Preview

3D Axonometry

09 Electrical

Lights - Push Button  
Switch



09 Electrical

Lights - Strip Lighting



09 Electrical

Lights - Strip Lighting

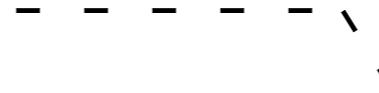

09 Electrical

Security - Alarm Contact



09 Electrical

Security - CCTV Ceiling





Folder 01

Folder 02

Folder 03

Library Part Name

2D Plan Preview

3D Axonometry

09 Electrical

Security - CCTV Wall



09 Electrical

Security - Card Reader



09 Electrical

Security - Electric Strike



09 Electrical

Security - Magnetic Lock



09 Electrical

Security - Push Button



Folder 01

Folder 02

Folder 03

Library Part Name

2D Plan Preview

3D Axonometry

09 Electrical

Security - V-Lock



M Master

Zone Stamp

Smart Zone Stamp 22

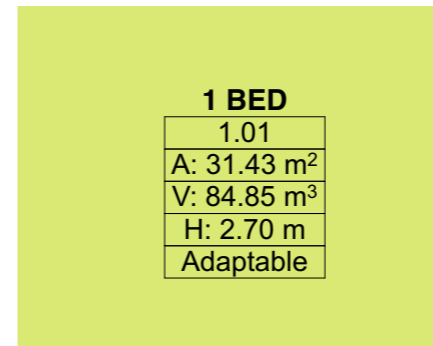

1 BED  
1.01  
A: 31.43 m<sup>2</sup>  
V: 84.85 m<sup>3</sup>  
H: 2.70 m  
Adaptable

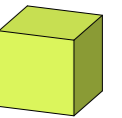



M Master

Zone Stamp

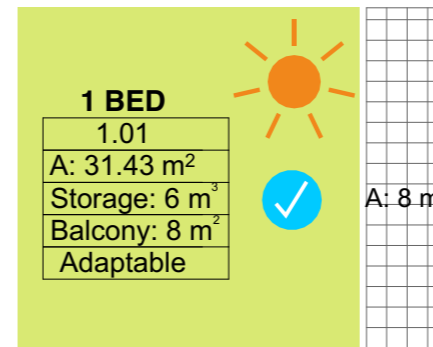
Smart Zone Stamp 24

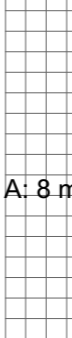

1 BED  
1.01  
A: 31.43 m<sup>2</sup>  
Storage: 6 m<sup>3</sup>  
Balcony: 8 m<sup>2</sup>  
Adaptable



A: 8 m<sup>2</sup>

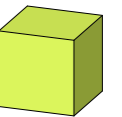

Folder 01

Folder 02

Folder 03

Library Part Name

2D Plan Preview

3D Axonometry

AS 1428

AS 1428-1\_2009\_Basin  
Clearance

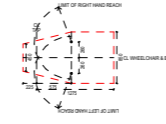

AS 1428

AS  
1428-1\_2009\_Circulation  
AtDoor

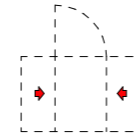

AS 1428

AS  
1428-1\_2009\_Circulation  
AtDoor\_Sliding

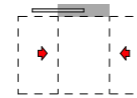

AS 1428

AS 1428\_1 2009\_  
Shower

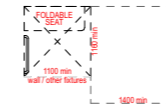

Folder 01

Folder 02

Folder 03

Library Part Name

2D Plan Preview

3D Axonometry

AS 1428

AS 1428\_1 2009\_  
Shower

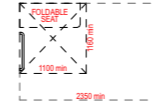

AS 1428

AS 1428\_1 2009\_WC

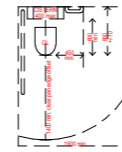

AS 1428

AS 1428\_Bed and  
Kitchen Circulation Space



AS 2890

2300x5000

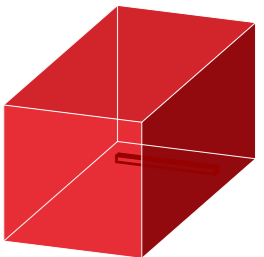
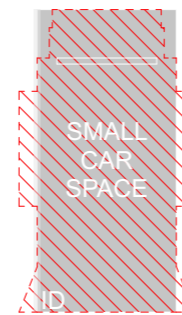

Folder 01

Folder 02

Folder 03

Library Part Name

2D Plan Preview

3D Axonometry

AS 2890

2400x5400

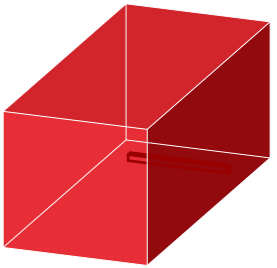
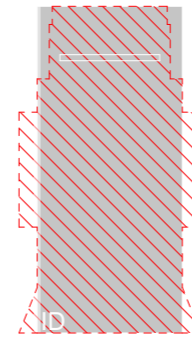

AS 2890

2500x5400

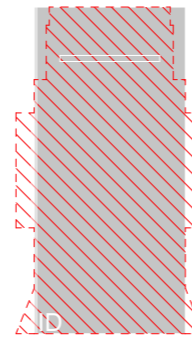

AS 2890

2600x5400

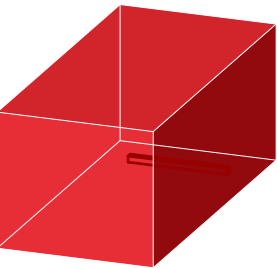
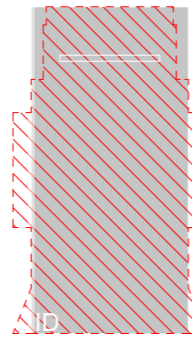

AS 2890

ACCESSIBLE

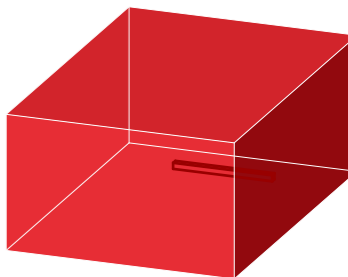
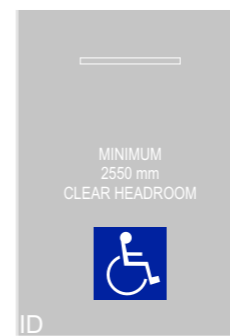

Folder 01

Folder 02

Folder 03

Library Part Name

2D Plan Preview

3D Axonometry

AS 2890

AS 2890 Parking Space  
Maker

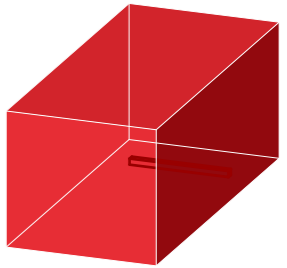
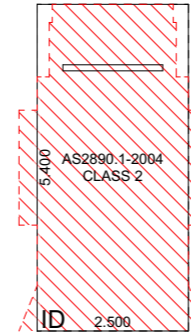

AS 2890

AS 2890 Parking Space  
Maker

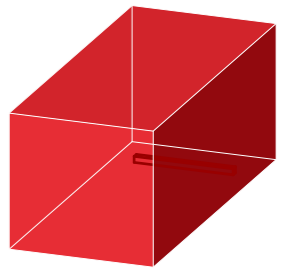
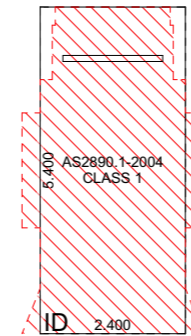

AS 2890

AS 2890 Parking Space  
Maker

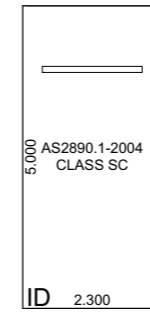

AS 2890

AS 2890 Parking Space  
Maker

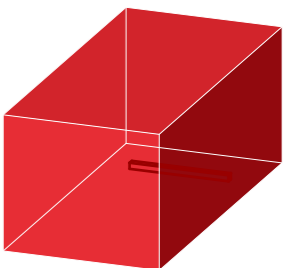
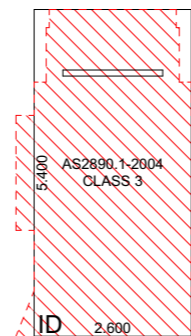

Folder 01

Folder 02

Folder 03

Library Part Name

2D Plan Preview

3D Axonometry

AS 2890

AS 2890 Parking Space  
Maker

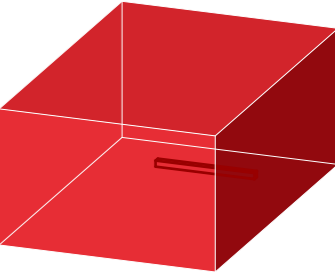
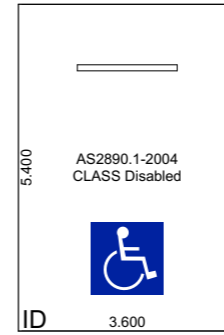

AS 2890

AS 2890 Parking Space  
Maker

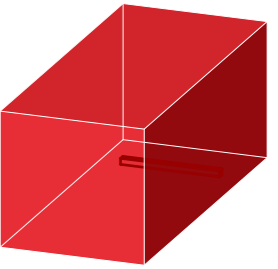
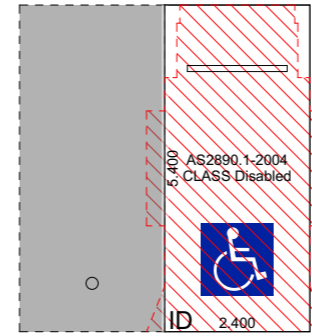

AS 2890

AS 2890 Swept Paths

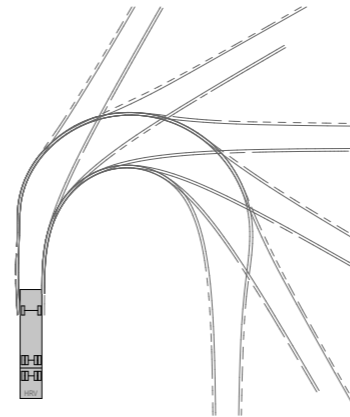

AS 2890

AS2890 PARALLEL 18

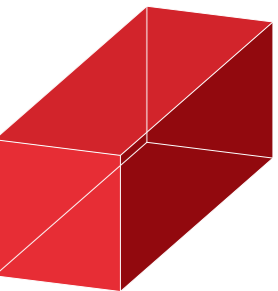



Folder 01

Folder 02

Folder 03

Library Part Name

2D Plan Preview

3D Axonometry

AS 2890

AS2890\_6

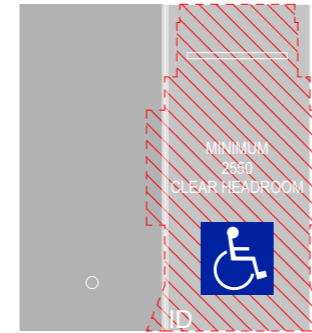

AS 2890

Car Wash Bay

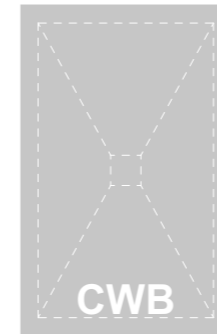

AS 2890

MOTORCYCLE



AS 2890

Articulated

AV

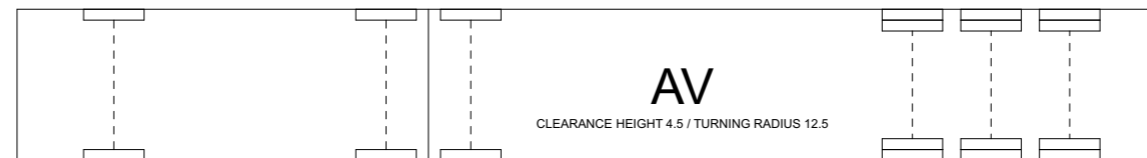

AS 2890

Articulated

HRV



AS 2890

Articulated

MRV



AS 2890

Articulated

SRV

